

# Perbaiki Tanah dengan Geosintetik

**DR. IR. NURLY GOFAR MSCE**

**Jurusan Teknik sipil**

**Universitas bina darma**

# Referensi

Robert M. Koerner (2005) *Designing with Geosynthetics 5<sup>th</sup> ed.*, Pearson Education/Prentice Hall.

Hand outs

# Definisi

*Geosynthetics are planar products manufactured from polymeric material used with soil, rock or other geotechnical engineering-related material as an integral part of a man-made project, structure or system (ASTM D4439, 1995).*

You can find a wide range of geosynthetic products such as:

# Geotextiles

## GEOTEXTILES



Woven geotextile

## WOVEN GEOTEXTILE

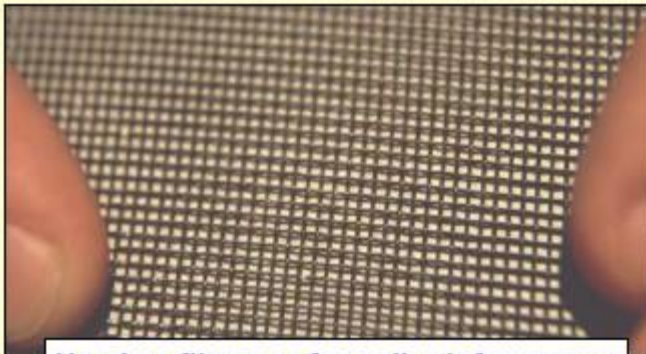

Used as filters or for soil reinforcement

## MICROPHOTOGRAPH OF NONWOVEN GEOTEXTILE

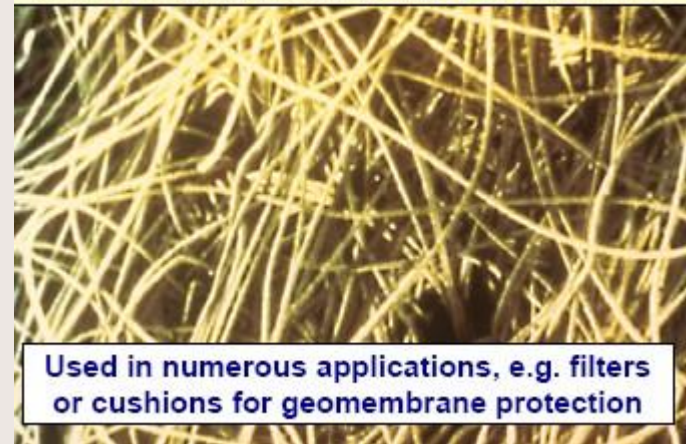

Used in numerous applications, e.g. filters or cushions for geomembrane protection



# Geogrids

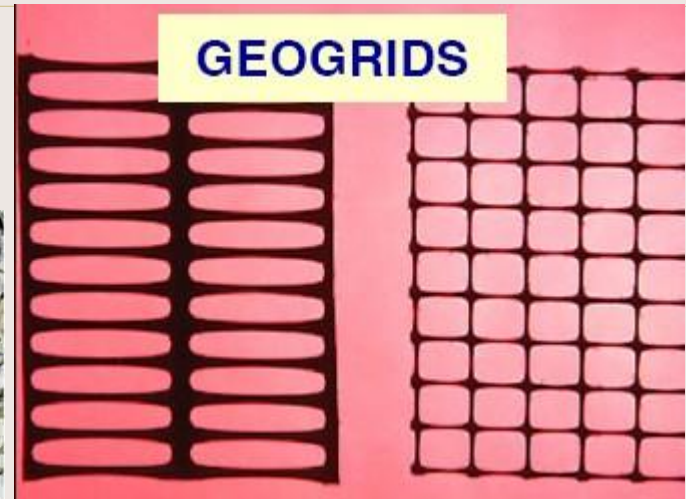
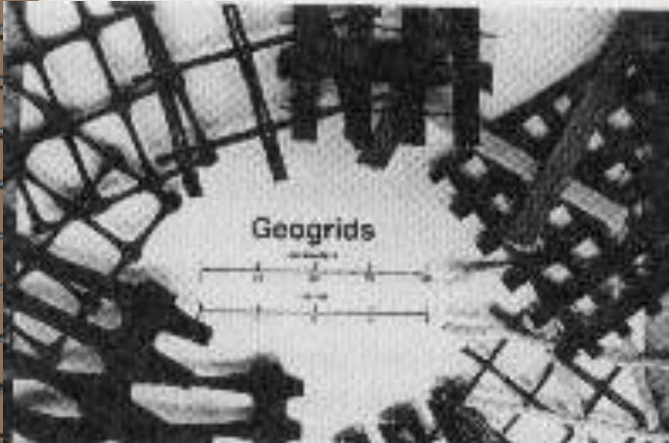

## PLACEMENT OF GEOGRIDS



## ROLLS OF GEOGRIDS



# Geonets

## GEONETS



Geonets can convey liquid and gas within their channels.

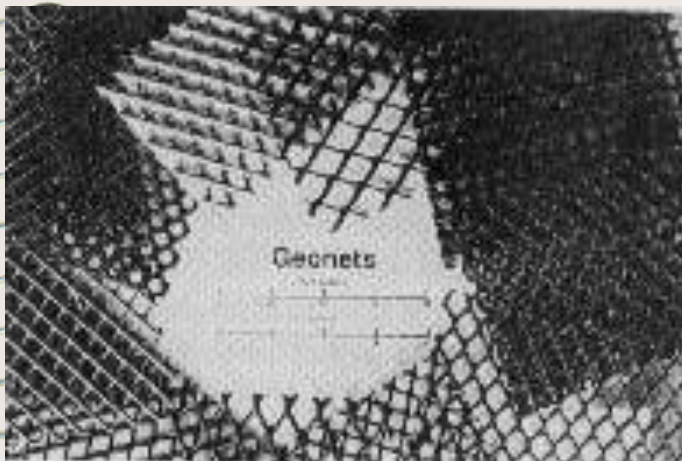
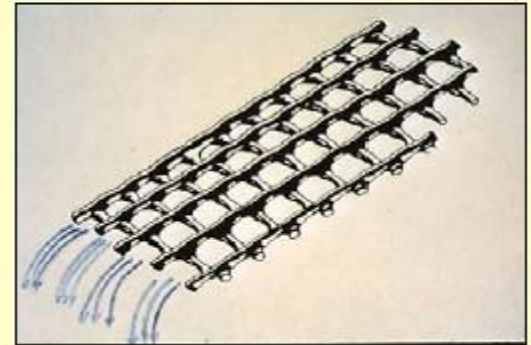



# Geomembranes

Geomembranes



# Geosynthetics Clay Liners

## GEOSYNTHETIC CLAY LINER (GCL)

NONWOVEN

(GCL)



BENTONITE

WOVEN

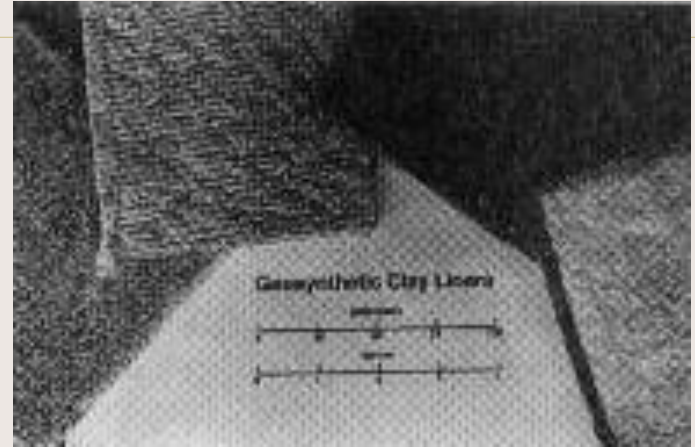

## GEOSYNTHETIC CLAY LINERS used as liquid barriers





# Geomats and Geocell

## GEOMATS



Used for erosion control

Geomat rolls used for erosion control



# Geocomposite

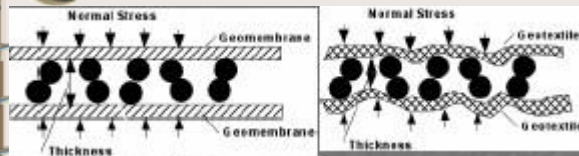

# Manfaat Penggunaan Geosintetik

---

- Kinerja yang lebih baik
- Lebih ekonomis (either low initial cost or through greater durability and longer life; thus reducing maintenance & replacement cost)



# Fungsi Geosintetik

- **Pemisah (*Separation*)**, dengan pemakaian geotekstil maka dapat memisahkan antara tanah timbunan dan tanah dasar di bawahnya.
- **Drainase (*Drainage*)**, mengalirkan air dari dalam tanah ataupun di permukaan tanah
- **Penyaring (*Filtration*)**, Terkait dengan fungsi filtrasi, maka geotekstil berfungsi sebagai filter mencegah masuknya air dan butiran halus dari tanah dasar ke dalam lapisan dasar timbunan
- **Perkuatan (*Reinforcement*)**, Maksudnya adalah geotekstil sebagai tulangan bagi tanah dasar untuk menyerap beban sementara yang diakibatkan oleh beban kendaraan.

# Fungsi Geosintetik

- Beneath highway **embankment**: separation and reinforcement
- Beneath railroad ballast: separation, reinforcement, filtration and drainage
- In flexible-forming systems to contain concrete, grout or soil: separation, reinforcement, and filtration
- For prevention of crack reflection in asphalt pavement overlays: reinforcement and waterproofing
- For landfill: containment (rare)

# Sebagai pemisah / Separator



TIMBUNAN JALAN



# Sebagai Pemisah (Separator)

- *geotextiles* are used to prevent road base materials from penetrating into soft underlying soft subgrade, thus maintaining design thickness and roadway integrity
- *geotextile* separators also prevent fine-grained subgrade soils from being pumped into permeable, granular road bases

Soil Fines Pump into Aggregate



Aggregate Intrudes Subgrade



Separation with Geosynthetic

Application of geotextile as separator:

Road (below and above embankment), Railway, parking areas

# Sebagai Pemisah (Separator)

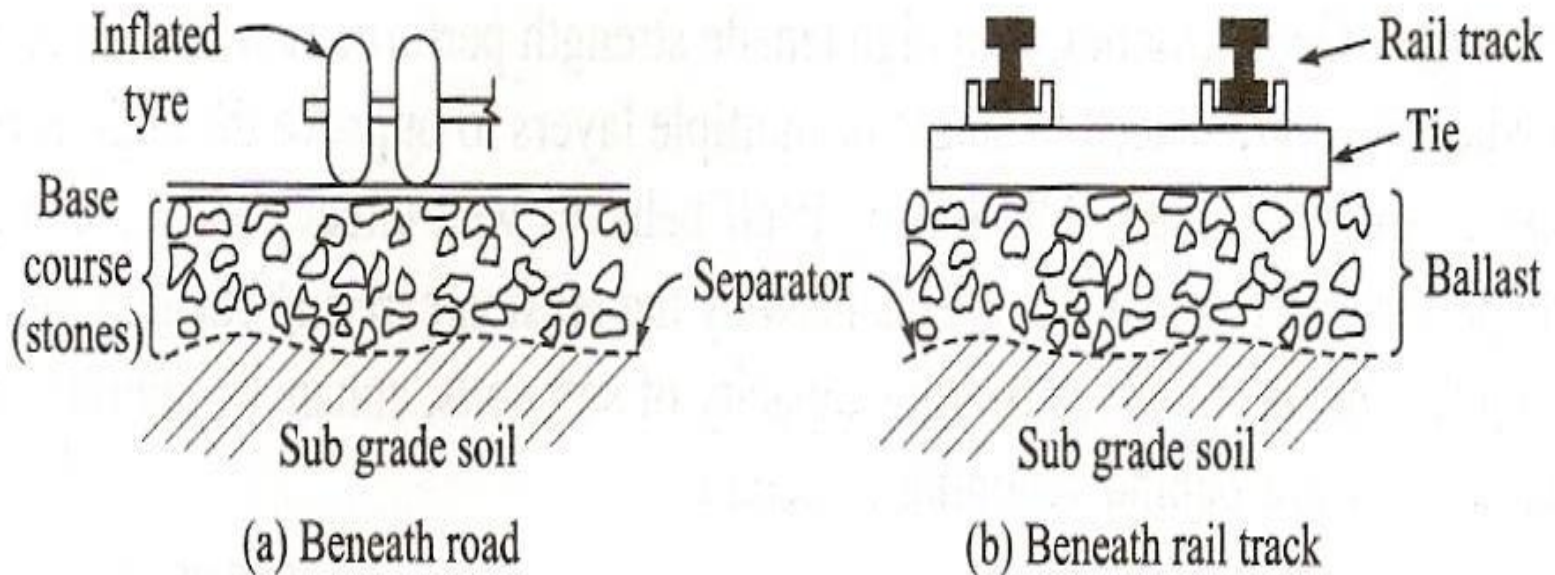

Geosynthetics as separators

# Sebagai Perkuatan (Reinforcement)

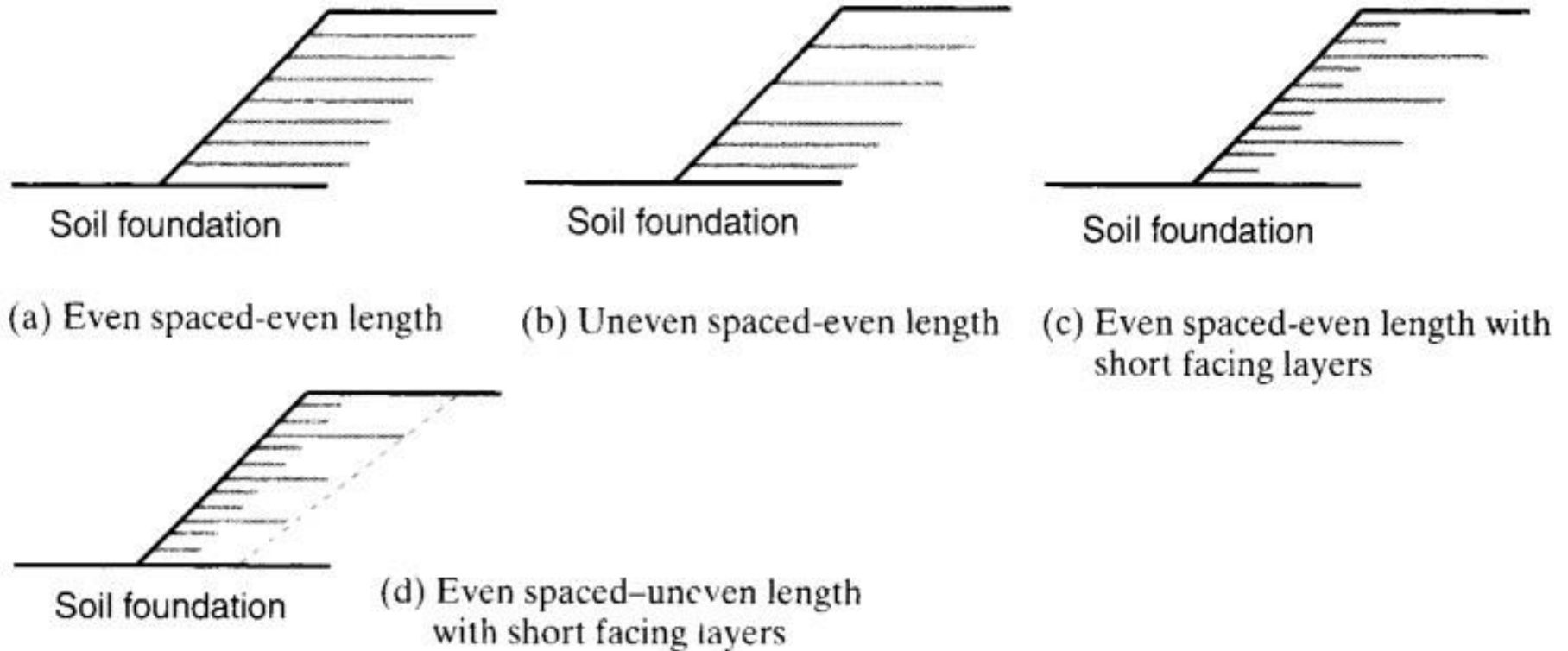

**Figure 2.49** Various geotextile deployment schemes for stabilizing steep soil embankments on firm foundations.



# Sebagai Perkuatan (Reinforcement)

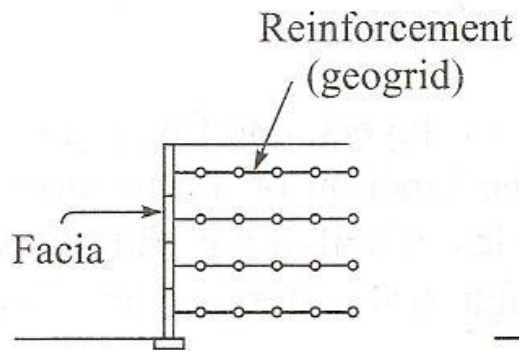

(a) Retaining wall

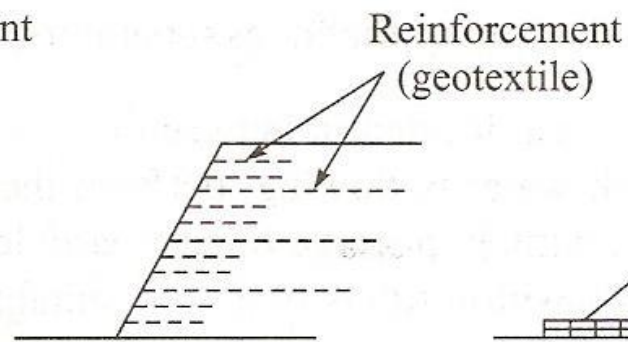

(b) Steep slope

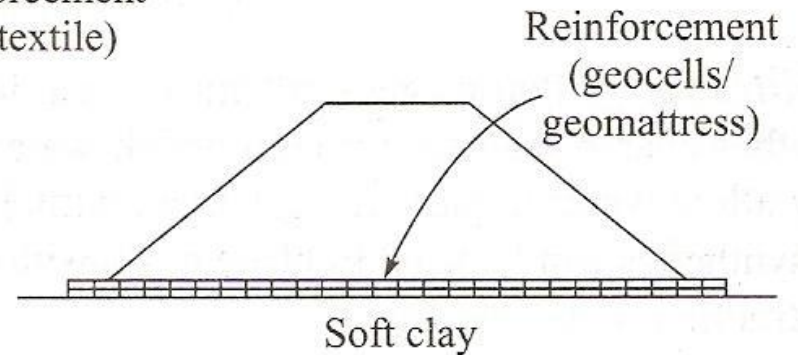

(c) Embankment on soft soil

Geosynthetics as reinforcement

# Sebagai Filtrasi

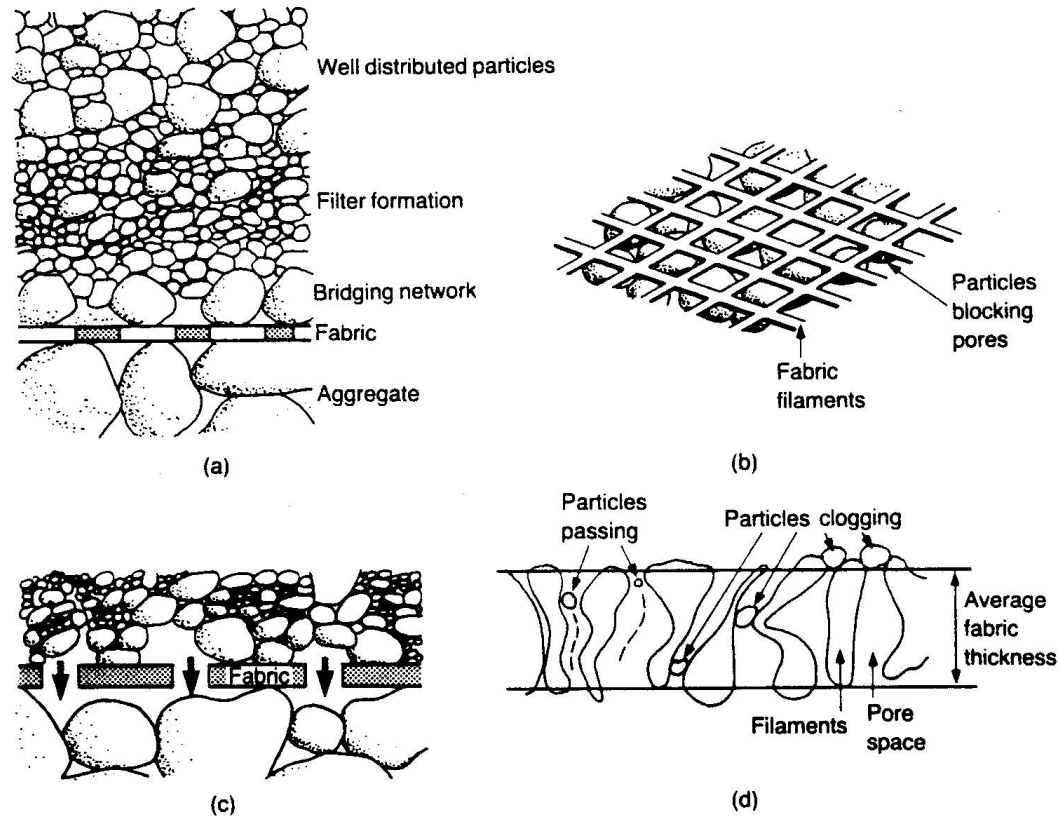
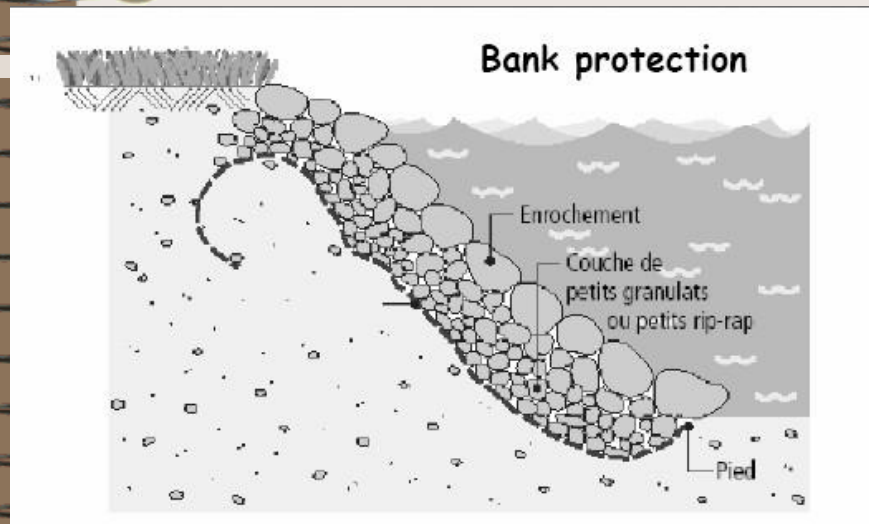
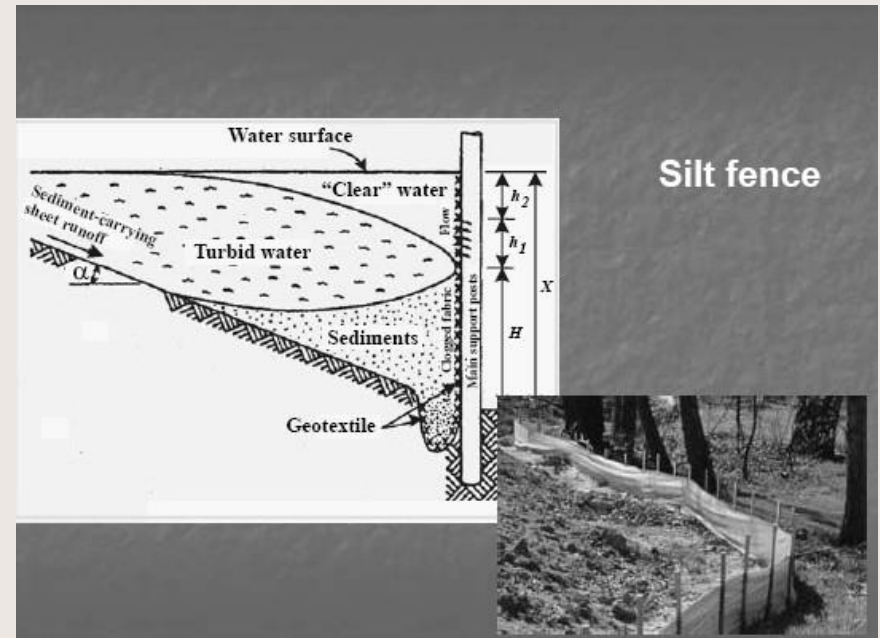
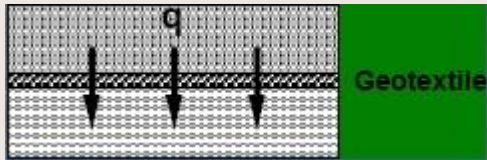

Figure VI.6 Various hypothetical mechanisms in soil geotextile compatibility

- (a) Formation of upstream soil filter
- (b) Upstream particles blocking openings
- (c) Upstream particles arching over openings
- (d) Particles clogged within geotextile structure

# Aplikasi sebagai Filtrasi



Pelindung sungai dan pantai

# Sebagai Filtrasi

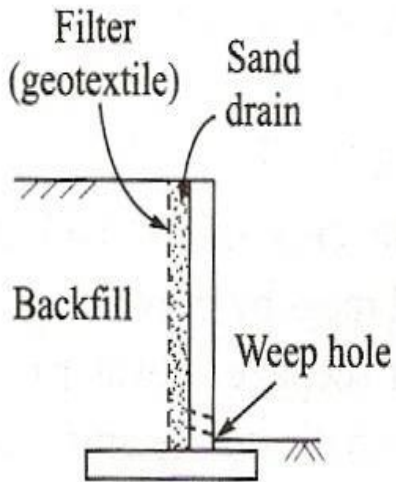

(a) Behind retaining wall

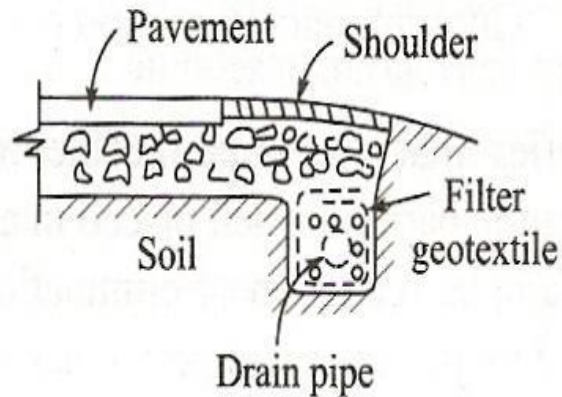

(b) Edge drain below road shoulder

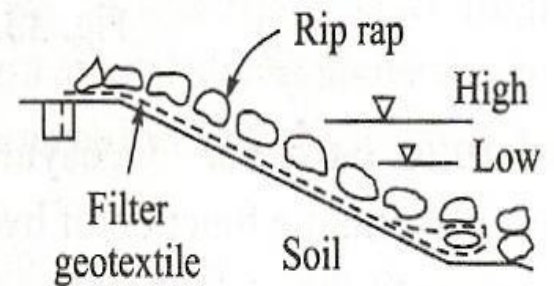

(c) Erosion control

Geosynthetics as transition filters



# Sebagai Pelindung terhadap Erosi

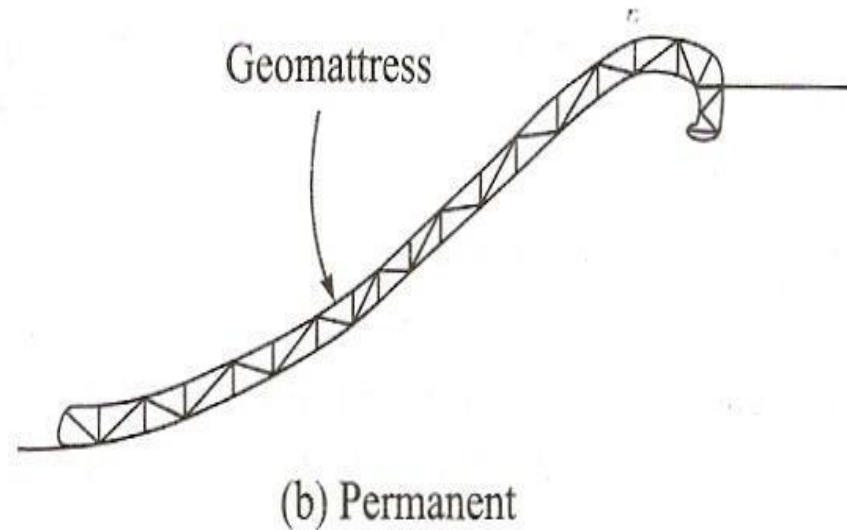
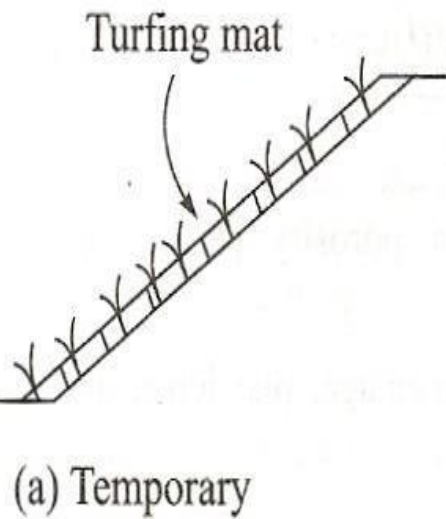

Geosynthetics used to control erosion

# Sebagai Drainase

- To transfer water, leachate, gas
- Along the geosynthetic (in its thickness)
- Adequate flow capacity under design loads to convey maximum anticipated seepage during design life
- Fabric placed in such a way as to transmit liquid within the plane of their structure provide a drainage function.
- Long term performance consideration

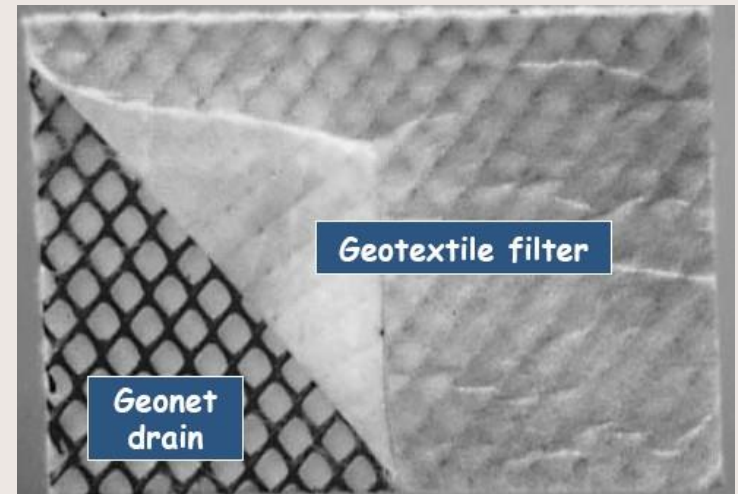
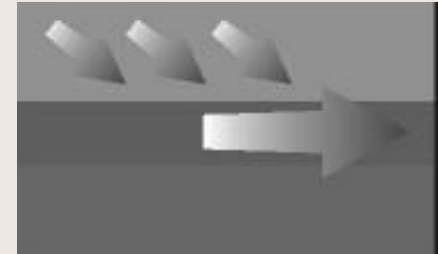

# Sebagai Drainase

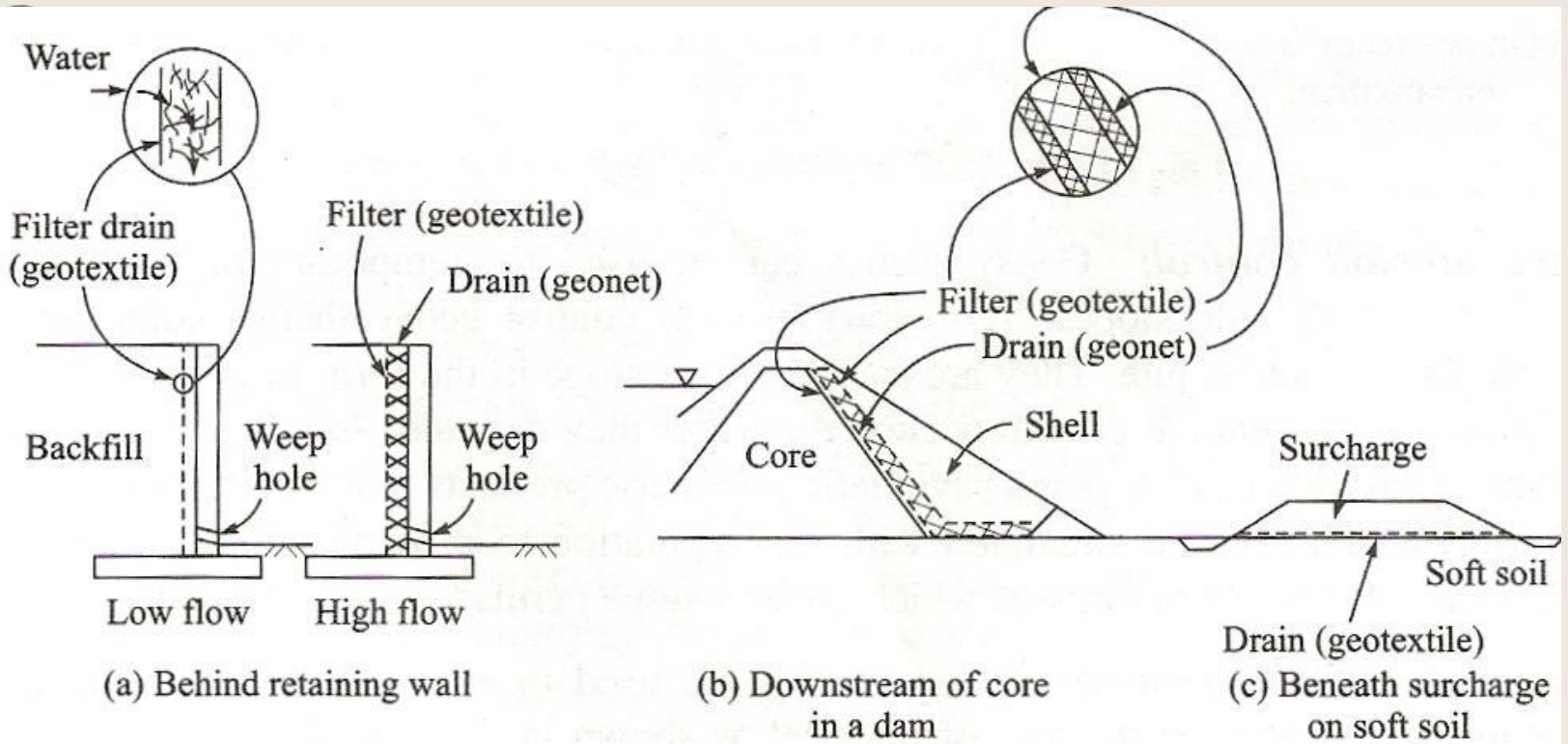

Geosynthetics as drains

# Sebagai Containment

## Landfill

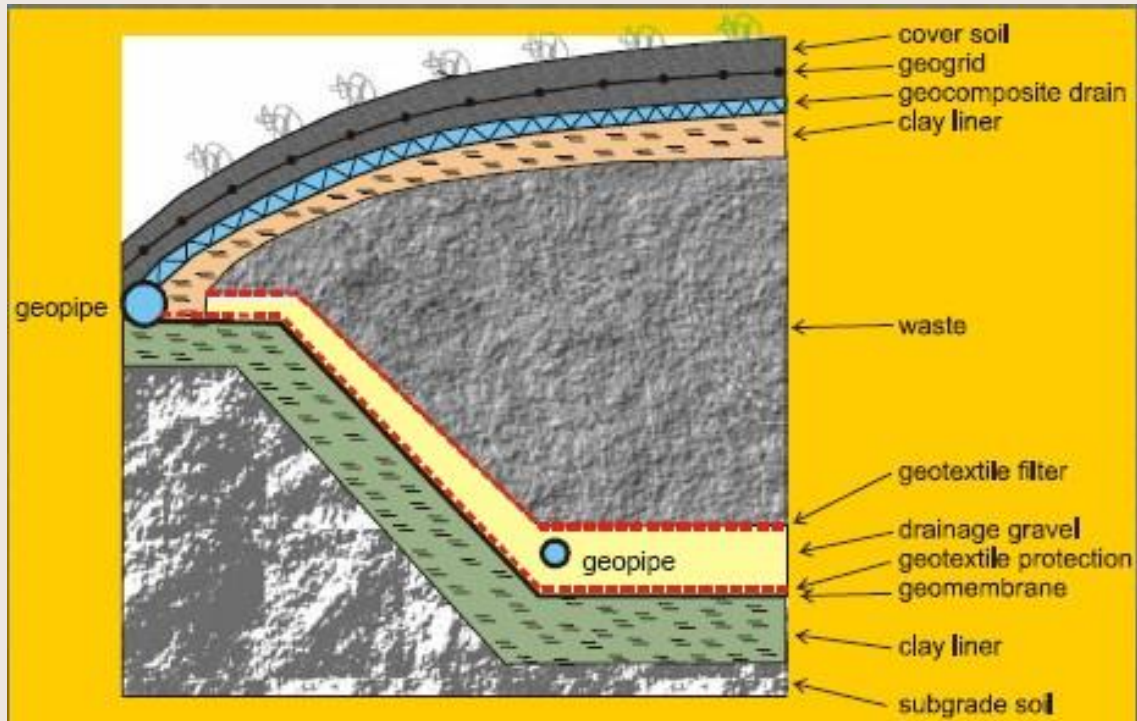



# Untuk kolam

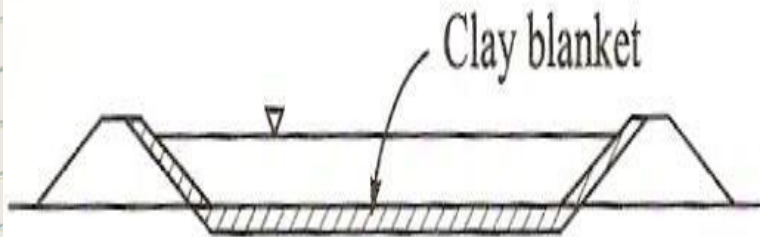

(a) Lined with clay

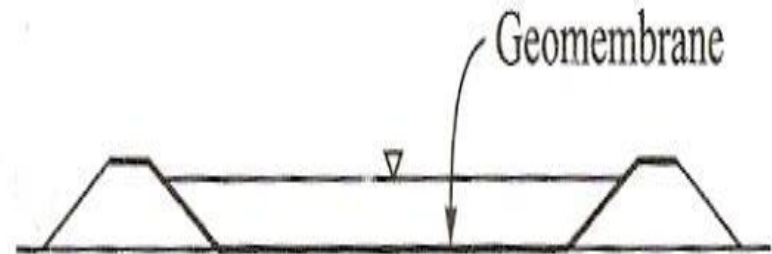

(b) Lined with geomembrane

Using geomembrane for a water storage pond

# Sebagai karung (Encapsulation)

Use to encapsulate soil or sediments to a specific geometry and prevent the loss of materials.

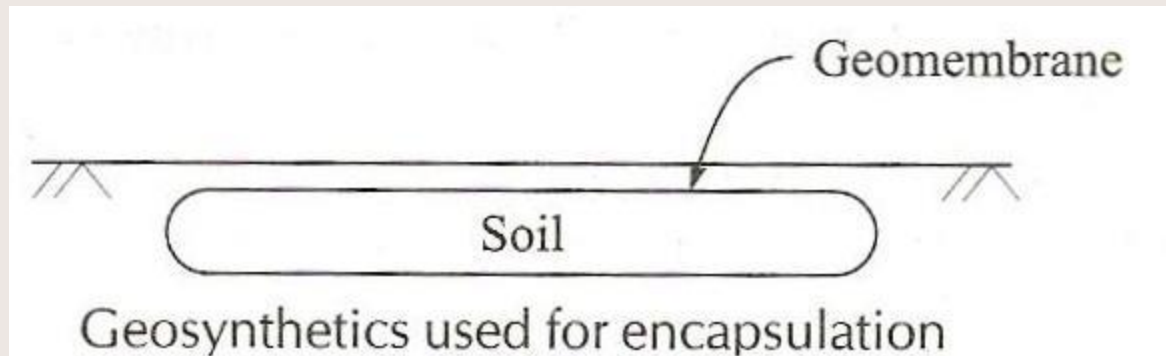

A silver metal spiral binding is visible on the left side of the page, looping through a series of holes in the paper. The binding is positioned vertically, extending from the top to the bottom of the page.

Terimakasih